

Features

- Locking unit is a mechanical device to apply to cylinders ISO 15552 and 6432 VDMA whose scope is to block cylinder's rod in any position. This solution allows to block the race of the cylinder anytime takes place an unexpected fall of pressure.
- The blocking force is always and however greater of the one developed from the respective cylinder at 10 kgf/cm².

Specification

Model	MCB									
Tube I.D. (mm)	20	25	32	40	50	63	80	100	125	
Rod diameter (mm)	8	10	12	16	20	20	25	25	32	
Medium	Air									
Operating pressure range	0.3~0.6 MPa									
Proof pressure	1.5 MPa									
Ambient temperature	-5~+80°C (No freezing)									
Min. working pressure	0.3 MPa									
Locking mode	Secure locking of piston rod in any position									
Lock retention forces (N) Max. static loading— Horizontal mounting	490	490	790	1240	1930	3060	5400	7700	12040	

Order example

MCB — 40

MODEL

TUBE I.D.

Other examples of locking unit applications

For slides

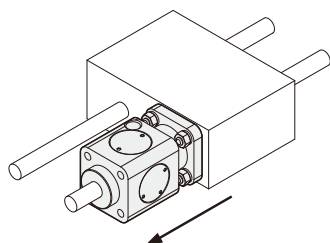

For piling

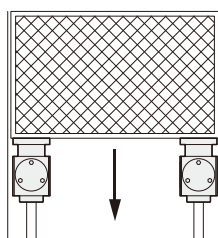

Chromium-plated shaft

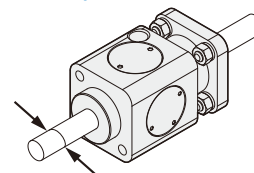

Tolerance	f7
Rod diameter	8, 10, 12, 16, 20, 25, 32

LOCKING UNIT

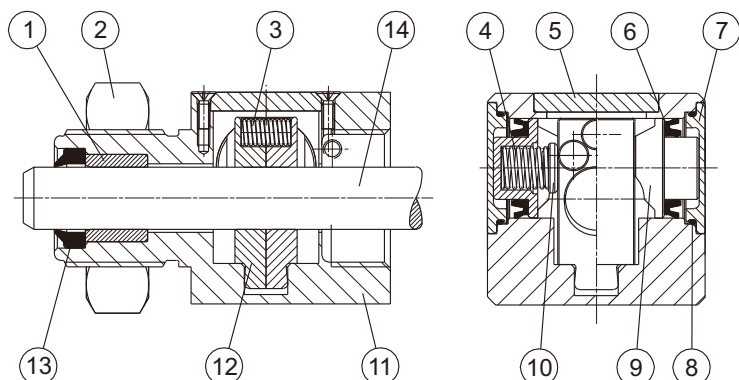

Material

No.	Part name	Material
1	Guida bush	Iglidur
2	Nut	Steel
3	Spring	Steel
4	Spring	Steel
5	Superior cover	Aluminum alloy
6	Seal piston	NBR
7	Lateral cover	Aluminum alloy
8	O-ring	NBR
9	Piston	Delrin
10	Spring cover	Delrin
11	Body	Aluminum alloy
12	Jaws	Bronze
13	Rod seal	NBR
14	Support pin	Carbon steel

Attention

- Locking unit functioning is static type (cylinder's rod stopped).
- Before using the brake, take care to stop cylinder's rod.

Assemble attention

- Unlocking the locking unit by supplying air to the ⑪ body of locking unit. Please don't take out the ⑭ support pin after unlocking the locking unit.
- Using piston rod to push the ⑭ support pin off until the piston rod replaces the position of the ⑭ support pin. Finally you can lock the piston rod by removing the air supply.
- ※ When the ⑪ body of locking unit is removed the air supply, if there is no ⑭ support pin or piston rod to support inside structure, it will cause the ⑫ jaws deviation. The piston rod can't be mounted anymore.

Connection scheme

Pneumatic control

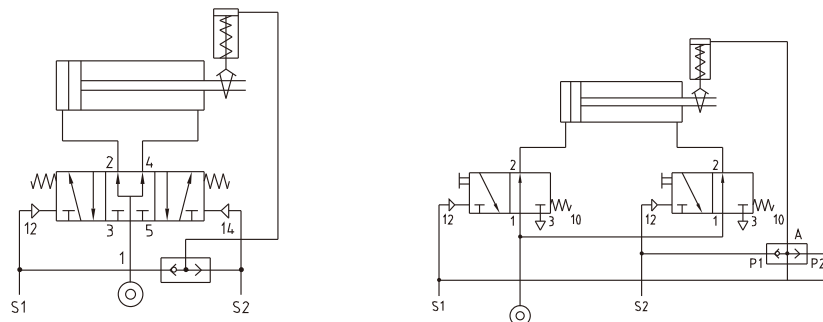

Electropneumatic control

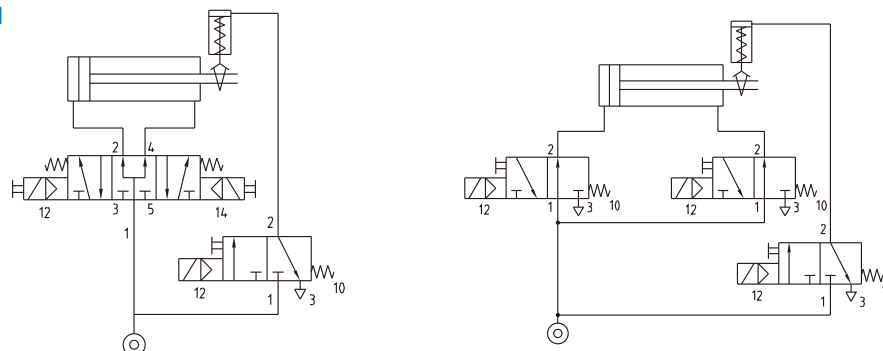

LOCKING UNIT

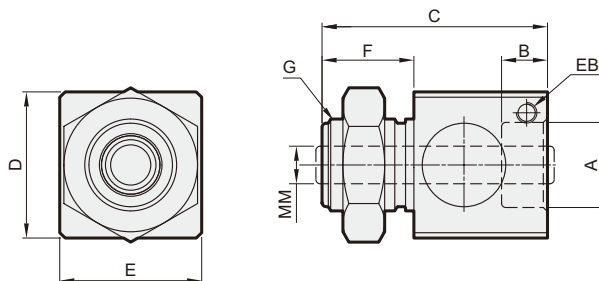

Code Tube I.D.	A	B	C	D	E	EB	F	G	MM	Weight (kg)
20	M22×1.5	11	54	35	34	M5	22	M22×1.5	$\phi 8^{T7}$	0.19
25	M22×1.5	11	54	35	34	M5	22	M22×1.5	$\phi 10^{T7}$	0.19

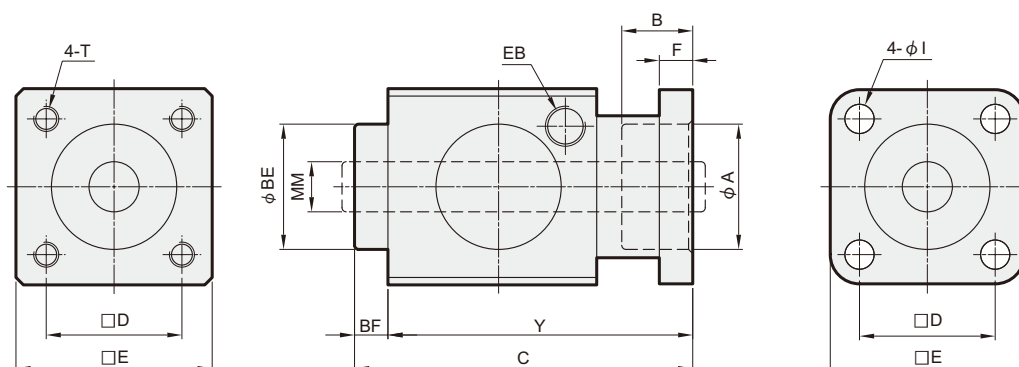

Code Tube I.D.	A	B	BE	BF	C	D	E	F	EB	I	MM	T	Y	Weight (kg)
32	30.5	19.5	30	7.5	67.5	32.5	47	6	G1/8	6.5	$\phi 12^{T7}$	M6×8L	60	0.4
40	35.5	22.5	34.9	10	80	38	54	6	G1/8	6.5	$\phi 16^{T7}$	M6×8L	70	0.6
50	40.5	29	40	10	100	46.5	65	8	G1/8	9	$\phi 20^{T7}$	M8×12L	90	1.1
63	45.5	29	45	10	100	56.5	75	8	G1/8	9	$\phi 20^{T7}$	M8×12L	90	1.5
80	45.5	37	45	10	120	72	95	12	G1/4	11	$\phi 25^{T7}$	M10×16L	110	2.6
100	55.5	39	55	10	120	89	114	12	G1/4	11	$\phi 25^{T7}$	M10×16L	110	3.5
125	60.5	51.5	60	16	156	110	138	20	G1/4	13	$\phi 32^{T7}$	M12×20L	140	6.5